

# GSIB1505 THRU GSIB15100

## SINGLE PHASE GLASS PASSIVATED BRIDGE RECTIFIER

Voltage: 50 to 1000V

Current: 15.0A



### Features

Glass passivated chip junction  
Ideal for printed circuit board  
High surge current capability  
High case dielectric strength  
This series is UL listed under Recognized Component Index, file number E330278

### Mechanical Data

Terminal: Plated leads solderable per J-STD-002  
Case: UL-94 Class V-0 recognized Flame Retardant Epoxy  
Polarity: Polarity symbol marked on body  
Mounting position: any

### GSIB-5S

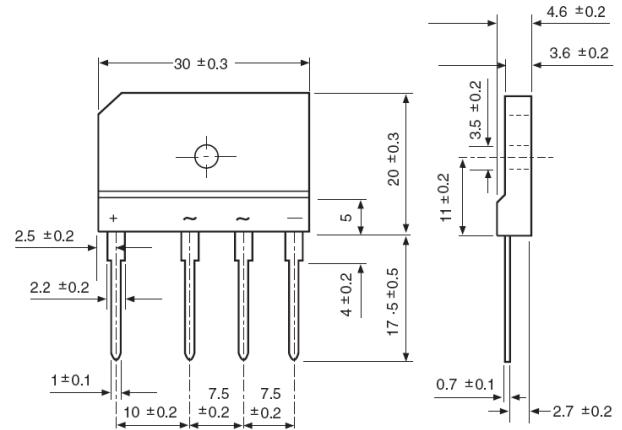

Dimensions in millimeters

### MAXIMUM RATINGS AND ELECTRICAL CHARACTERISTICS

(single-phase, half -wave, 60HZ, resistive or inductive load rating at 25°C, unless otherwise stated)

	Symbol	GSIB1 505	GSIB1 510	GSIB1 520	GSIB1 540	GSIB1 560	GSIB1 580	GSIB1 5100	units	
Maximum repetitive peak reverse voltage	V <sub>rrm</sub>	50	100	200	400	600	800	1000	V	
Maximum RMS voltage	V <sub>rms</sub>	35	70	140	280	420	560	700	V	
Maximum DC blocking voltage	V <sub>dc</sub>	50	100	200	400	600	800	1000	V	
Maximum average forward Rectified output current at T <sub>c</sub> = 107°C (Note 1) Ta = 25°C (Note 2)	I <sub>f(av)</sub>	15.0						3.5		A
Peak forward surge current single sine-wave superimposed on rated load (JEDEC Method)	I <sub>fsm</sub>	300								A
Maximum instantaneous forward voltage drop per leg at 7.5A	V <sub>f</sub>	1.0								V
Rating for fusing (t < 8.3ms)	I <sup>2</sup> t	240								A <sup>2</sup> Sec
Maximum DC reverse current at rated DC blocking voltage per leg Ta = 25°C Ta = 125°C	I <sub>r</sub>	10.0						250		μA
Maximum thermal resistance per leg (Note2) (Note1)	R <sub>th(ja)</sub> R <sub>th(jc)</sub>	22.0						1.5		°C/W
Operating junction and storage temperature range	T <sub>j</sub> , T <sub>stg</sub>	-55 to +150								°C

Note:

1. Unit case mounted on Al plate heatsink
2. Unit case mounted on P.C.B. without heatsink
3. Recommended mounting position is to bolt down on heatsink with silicone thermal compound for maximum heat transfer with #6 screw

**RATINGS AND CHARACTERISTIC CURVES GSIB1505 THRU GSIB15100**

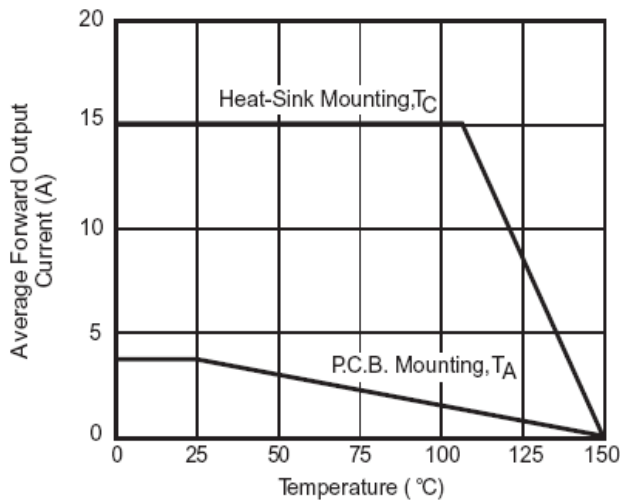

Figure 1. Derating Curve Output Rectified Current

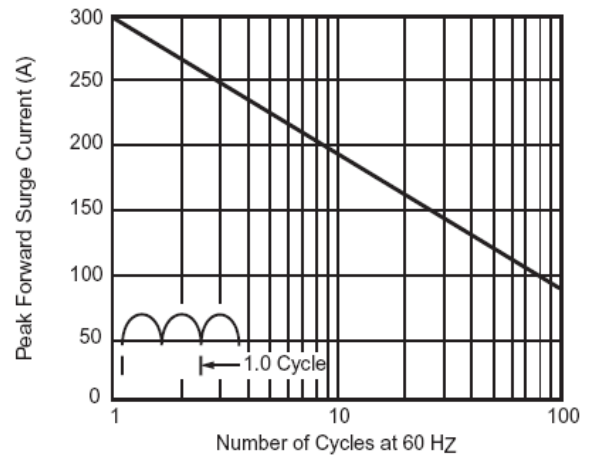

Figure 2. Maximum Non-Repetitive Peak Forward Surge Current Per Leg

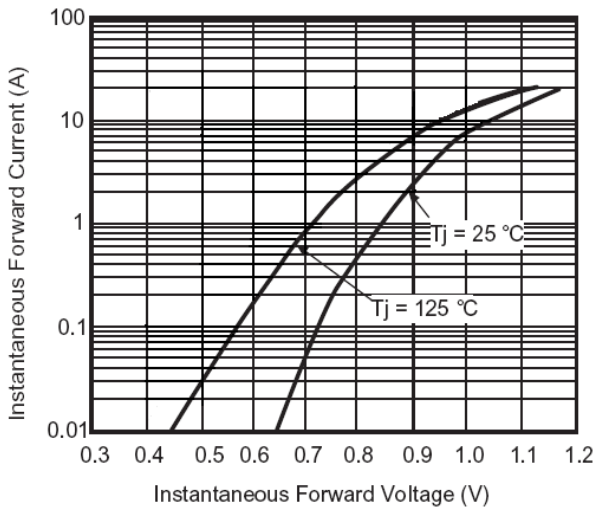

Figure 3. Typical Forward Characteristics Per Leg

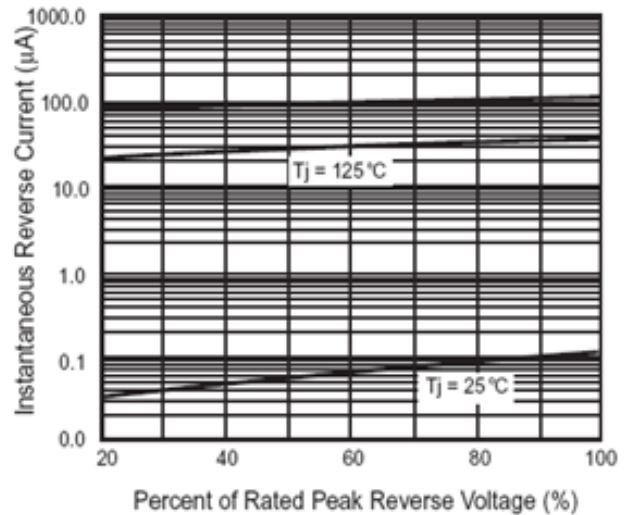

Figure 4. Typical Reverse Characteristics Per Leg

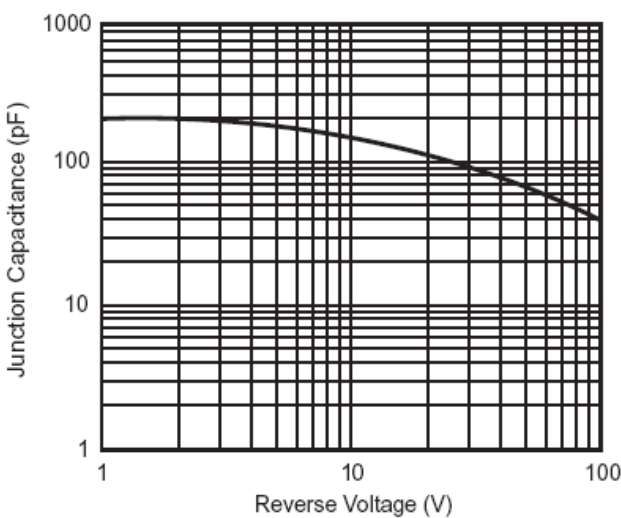

Figure 5. Typical Junction Capacitance Per Leg

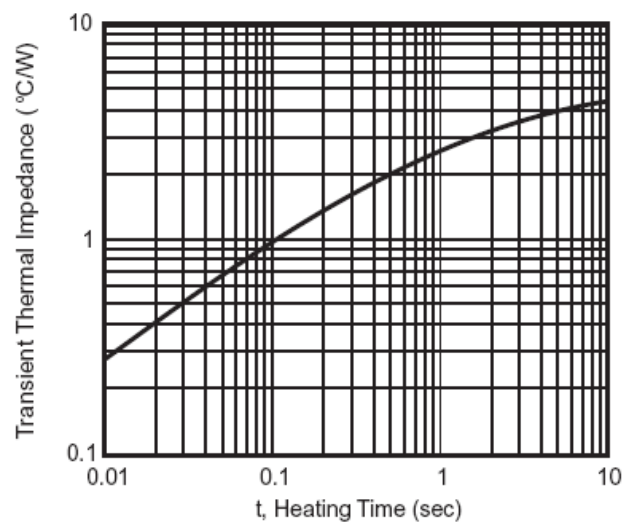

Figure 6. Typical Transient Thermal Impedance