

GSIB6A05 THRU GSIB6A100

SINGLE PHASE GLASS PASSIVATED BRIDGE RECTIFIER

Voltage: 50 to 1000V

Current: 6.0A

Features

Glass passivated chip junction
Ideal for printed circuit board
High surge current capability
High case dielectric strength
This series is UL listed under Recognized Component Index, file number E330278

Mechanical Data

Terminal: Plated leads solderable per J-STD-002
Case: UL-94 Class V-0 recognized Flame Retardant Epoxy
Polarity: Polarity symbol marked on body
Mounting position: any

GSIB-5S

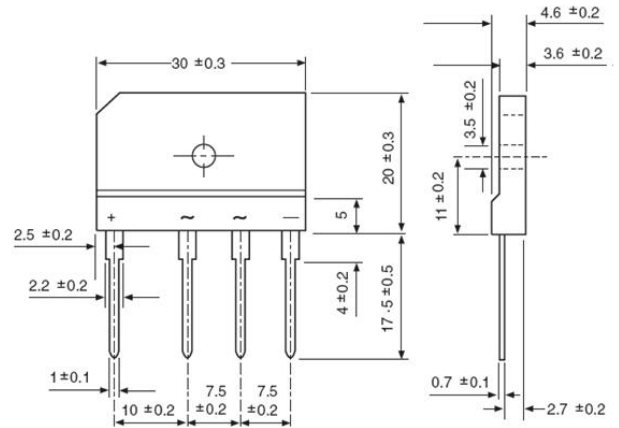

Dimensions in millimeters

MAXIMUM RATINGS AND ELECTRICAL CHARACTERISTICS

(single-phase, half -wave, 60HZ, resistive or inductive load rating at 25°C, unless otherwise stated)

	Symbol	GSIB6 A05	GSIB6 A10	GSIB6 A20	GSIB6 A40	GSIB6 A60	GSIB6 A80	GSIB6 A100	units
Maximum repetitive peak reverse voltage	V _{rrm}	50	100	200	400	600	800	1000	V
Maximum RMS voltage	V _{rms}	35	70	140	280	420	560	700	V
Maximum DC blocking voltage	V _{dc}	50	100	200	400	600	800	1000	V
Maximum average forward Rectified output current at T _c = 100°C (Note 1) Ta = 25°C (Note 2)	I _{f(av)}	6.0 2.8							A
Peak forward surge current single sine-wave superimposed on rated load (JEDEC Method)	I _{fsm}	150							A
Maximum instantaneous forward voltage drop per leg at 3.0A	V _f	1.0							V
Rating for fusing (t < 8.3ms)	I ² t	93							A ² Sec
Maximum DC reverse current at rated DC blocking voltage per leg Ta = 25°C Ta = 125°C	I _r	10.0 250							μA
Maximum thermal resistance per leg (Note2) (Note1)	R _{th(ja)} R _{th(jc)}	22.0 3.4							°C/W
Operating junction and storage temperature range	T _j , T _{stg}	-55 to +150							°C

Note:

- Unit case mounted on Al plate heatsink
- Unit case mounted on P.C.B. with 0.5 x 0.5" (12 x 12mm) copper pads and 0.375" (9.5mm) lead length
- Recommended mounting position is to bolt down on heatsink with silicone thermal compound for maximum heat transfer with #6 screw

RATINGS AND CHARACTERISTIC CURVES GSIB6A05 THRU GSIB6A100

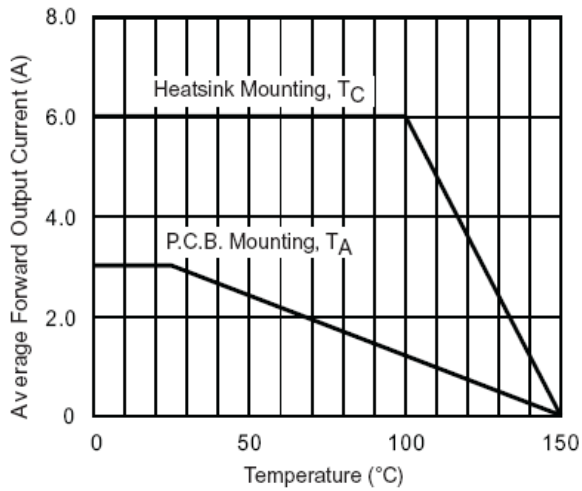

Figure 1. Derating Curve Output Rectified Current

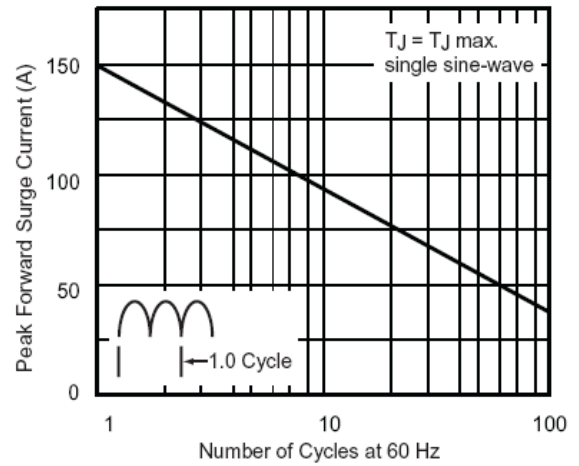

Figure 2. Maximum Non-Repetitive Peak Forward Surge Current Per Leg

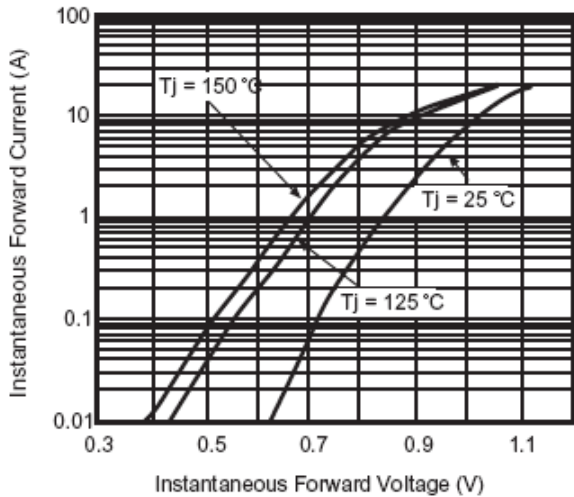

Figure 3. Typical Forward Characteristics Per Leg

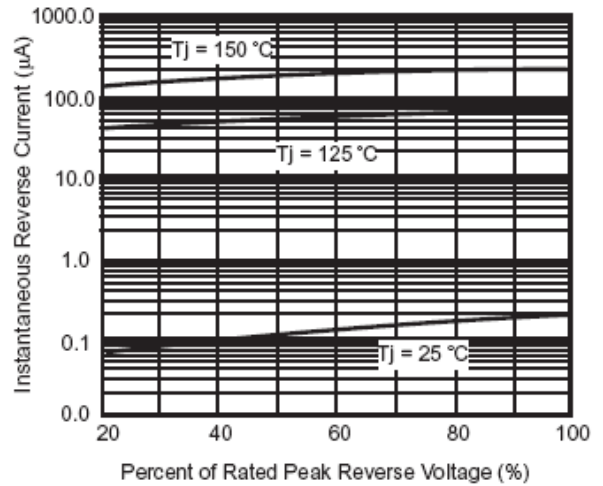

Figure 4. Typical Reverse Characteristics Per Leg

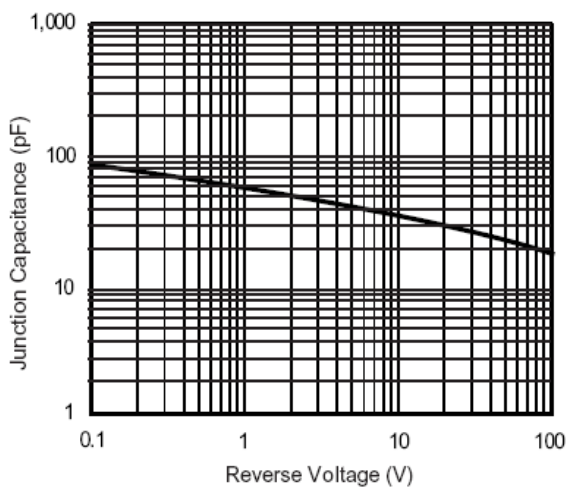

Figure 5. Typical Junction Capacitance Per Leg

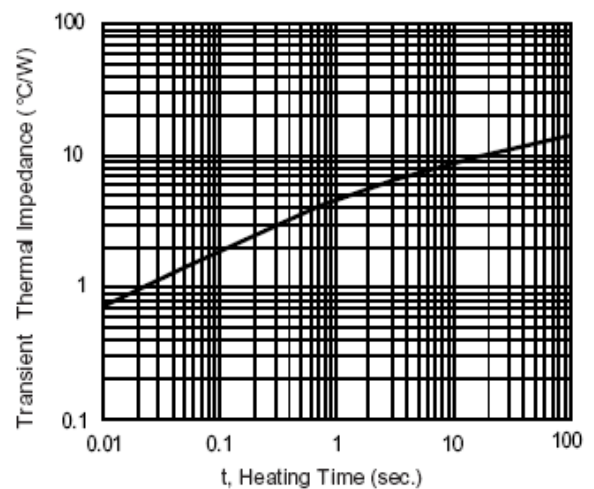

Figure 6. Typical Transient Thermal Impedance