

LLB005-E-47L THRU LLB10-E-47L

**SINGLE PHASE GLASS PASSIVATED
SURFACE MOUNT FLAT BRIDGE RECTIFIER**
VOLTAGE: 50 to 1000V CURRENT: 1.0A



FEATURE

Ideal for printed circuit board
Glass passivated chip
Reliable low cost construction utilizing molded plastic technique
High surge current capability
Small size, simple installation
High temperature soldering guaranteed: 260°C/10 seconds
Halogen Free

MECHANICAL DATA

Terminal: Plated leads solderable per J-STD-002
Case: UL-94 Class V-0 recognized Halogen Free Epoxy
Polarity: Polarity symbol marked on body

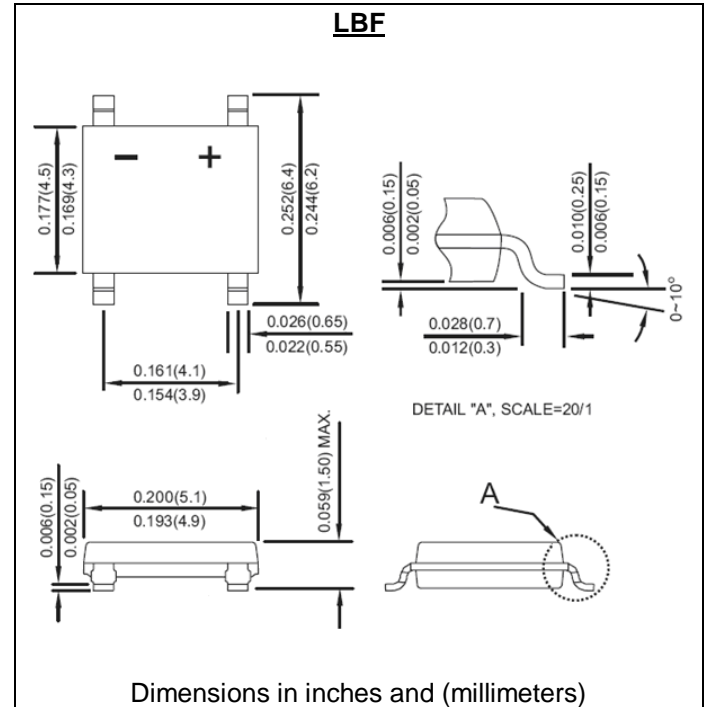

MAXIMUM RATINGS AND ELECTRICAL CHARACTERISTICS

(single-phase, half -wave, 60HZ, resistive or inductive load rating at 25°C, unless otherwise stated)

	Symbol	LLB0 05-E- 47L	LLB0 1-E- 47L	LLB0 2-E- 47L	LLB0 4-E- 47L	LLB0 6-E- 47L	LLB0 8-E- 47L	LLB1 0-E- 47L	Units
Maximum Recurrent Peak Reverse Voltage	V _{rrm}	50	100	200	400	600	800	1000	V
Maximum RMS Voltage	V _{rms}	35	70	140	280	420	560	700	V
Maximum DC blocking Voltage	V _{DC}	50	100	200	400	600	800	1000	V
Maximum Average Forward Rectified Current on aluminum substrate on glass-epoxy P.C.B.	I _{f(av)}					1.0 0.8			A
Peak Forward Surge Current 8.3ms single half sine-wave superimposed on rated load	I _{fsm}					30.0			A
Maximum Instantaneous Forward Voltage at forward current 0.4A	V _f					0.95			V
Rating for fusing (t < 8.3ms)	I ² t					3.9			A ² sec
Maximum DC Reverse Current at rated DC blocking voltage Ta = 25°C Ta = 125°C	I _r					5.0 100.0			μA
Non Repetitive Reverse Avalanche Energy at I _{BR(R)} = 0.5A	E _r					5			mJ
Typical Thermal resistance junction to lead on aluminum substrate on glass-epoxy P.C.B.	R _{th(jl)} R _{th(ja)}					25 62.5 80			°C/W
Storage and Operating Junction Temperature Range	T _{stg} , T _j					-55 to +150			°C

Note:

RATINGS AND CHARACTERISTIC CURVES LLB005-E-47L THRU LLB10-E-47L

FIG.1- MAXIMUM FORWARD CURRENT DERATING CURVE

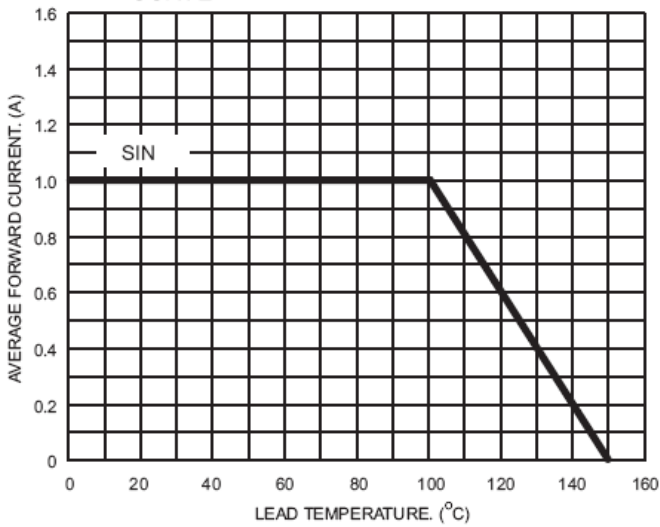

FIG.2- TYPICAL FORWARD CHARACTERISTICS

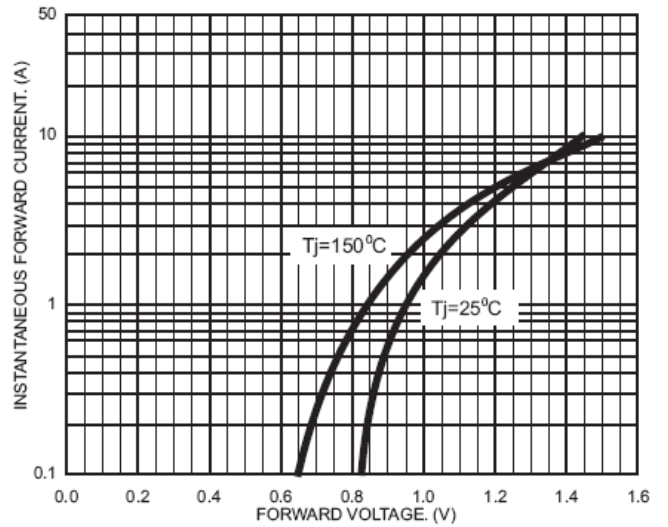

FIG.3- MAXIMUM FORWARD CURRENT DERATING CURVE

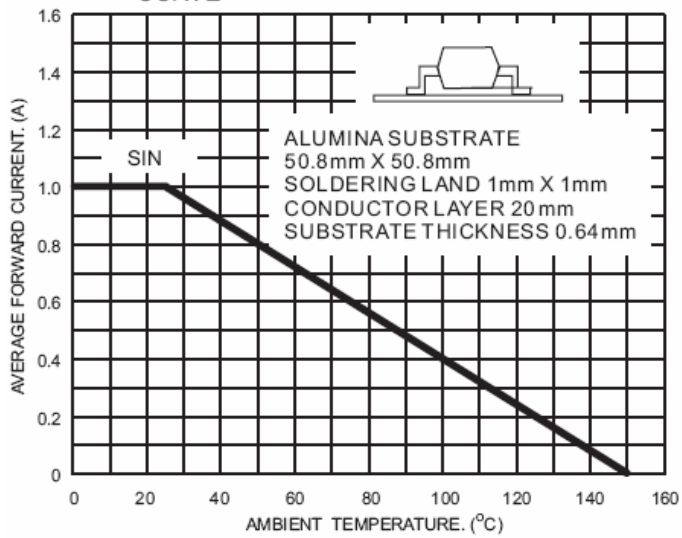

FIG.4- FORWARD POWER DISSIPATION

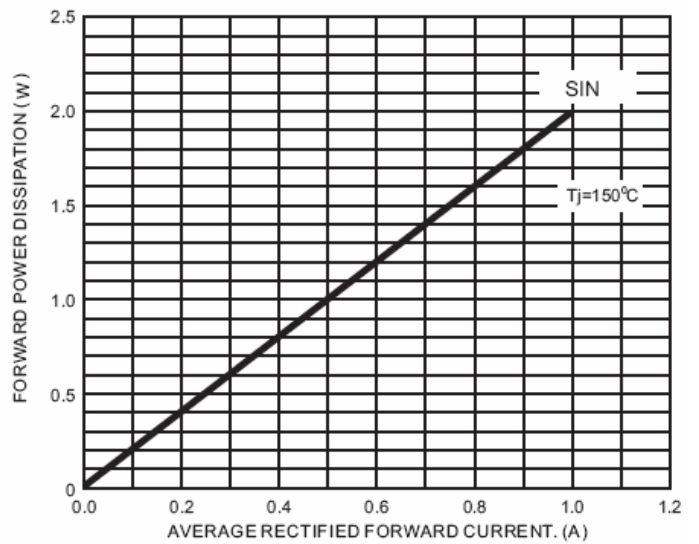

FIG.5- MAXIMUM NON-REPETITIVE FORWARD SURGE CURRENT

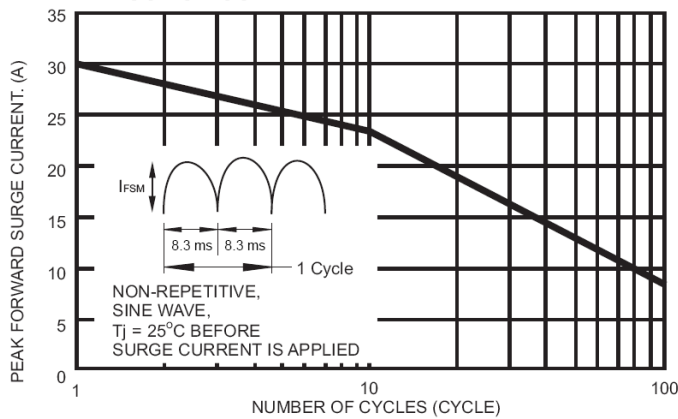
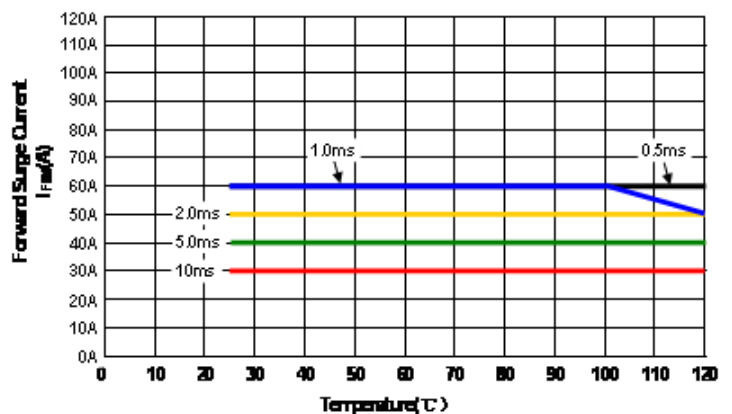
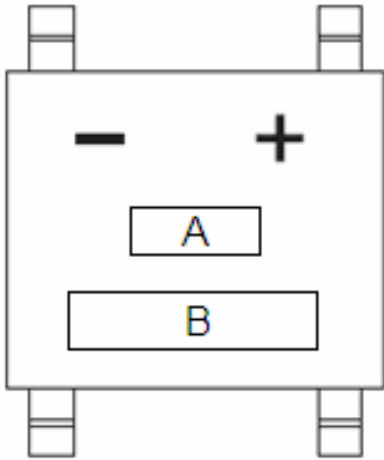

Fig.6 — Maximum Non-Repetitive Peak Forward Surge Current (0.5ms ~ 10ms)



MARKING LLB005-E-47L THRU LLB10-E-47L



A: LOGO



E

B: TYPE NAME

LLB08

PACKING SPEC LLB005-E-47L THRU LLB10-E-47L

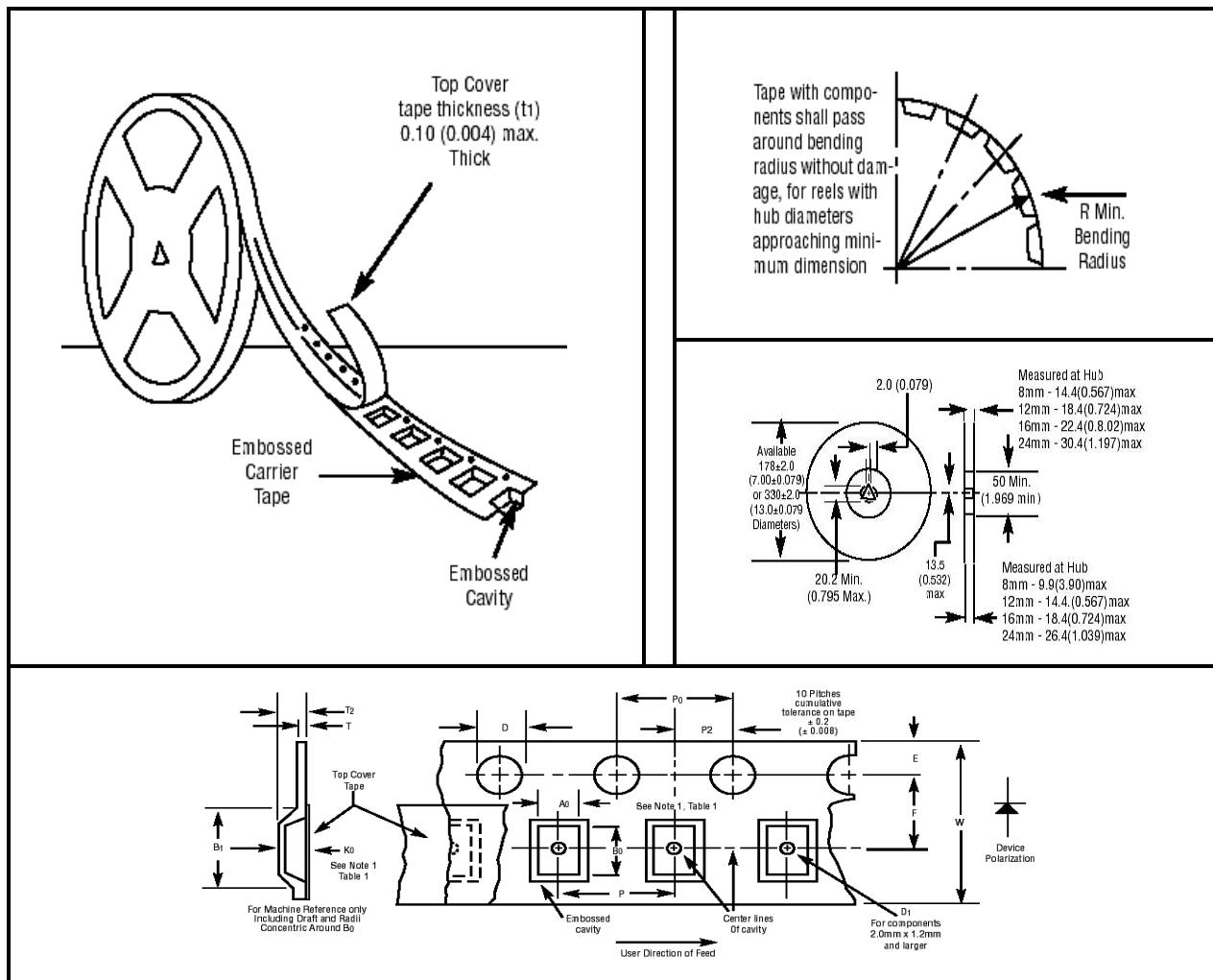

	LBF (mm)
A ₀ (TYP)	6.0
B ₀ (TYP)	8.3
K ₀ (TYP)	1.6
W	12±0.3
P ₀	4±0.1
P ₂	2±0.5
D	1.55±0.01
E	1.75±0.1
F	5.5±0.05
T (TYP)	0.6

TYPE AND REEL PACKAGING:

Component Case Type	Units Per Reel(pcs)	Component Spacing (mm)	Tape Spacing (mm)	Approx Gross Weight Per Reel Material(kg)	Approx Gross Weight Per Reel packed (kg)	Approx Gross Weight Per Box packed (kg)
LLB08-E	5000x2	4	12	0.272	0.922	2.004

Carton Size (cm)	Carton No.	Qty Per Carton (pcs)	Net Weight (kg)	Approx Gross Weight (kg)
35.5x35.5x34.5	05N	80K	15.8	16.8