

LS6GB60

SINGLE PHASE GLASS PASSIVATED BRIDGE RECTIFIER

Voltage: 600V

Current: 6.0A

Features

Glass passivated chip junction
Ideal for printed circuit board
High surge current capability
High case dielectric strength
This series is UL listed under Recognized Component Index, file number E330278

Mechanical Data

Terminal: Plated leads solderable per J-STD-002
Case: UL-94 Class V-0 recognized Flame Retardant Epoxy
Polarity: Polarity symbol marked on body
Mounting position: any

GSIB-5S

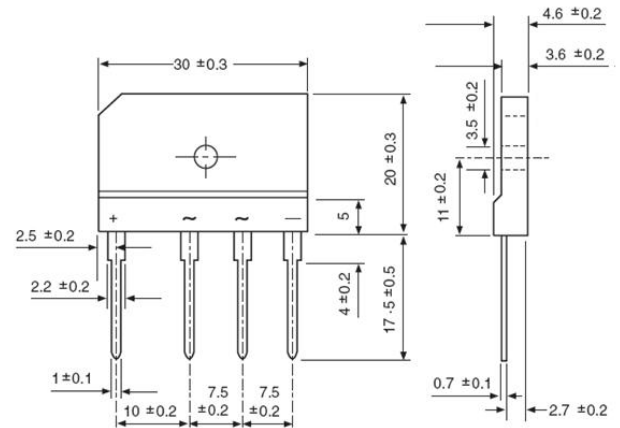

Dimensions in millimeters

MAXIMUM RATINGS AND ELECTRICAL CHARACTERISTICS

(single-phase, half -wave, 60HZ, resistive or inductive load rating at 25°C, unless otherwise stated)

	Symbol	LS6GB60	units
Maximum repetitive peak reverse voltage	V _{rrm}	600	V
Maximum RMS voltage	V _{rms}	420	V
Maximum DC blocking voltage	V _{dc}	600	V
Maximum average forward Rectified output current at T _c = 100°C (Note 2) Ta = 25°C (Note 32)	I _{f(av)}	6.0 2.8	A
Peak forward surge current single sine-wave superimposed on rated load (JEDEC Method)	I _{fsm}	200	A
Maximum instantaneous forward voltage drop per leg at 3.0A	V _f	0.95	V
Rating for fusing (t < 8.3ms)	I ² t	135	A ² Sec
Maximum DC reverse current at rated DC blocking voltage per leg Ta = 25°C Ta = 125°C	I _r	10.0 250	μA
Maximum Reverse Recovery Time (Note 1)	T _{rr}	1000	nS
Maximum thermal resistance per leg (Note 3) (Note 2)	R _{th(ja)} R _{th(jc)}	22.0 3.4	°C/W
Operating junction and storage temperature range	T _j , T _{stg}	-55 to +150	°C

Note:

- Reverse Recovery Condition I_f = 0.5A, I_r = 1.0A, I_{rr} = 0.25A
- Unit case mounted on Al plate heatsink
- Unit case mounted on P.C.B. with 0.5 x 0.5" (12 x 12mm) copper pads and 0.375"(9.5mm) lead length
- Recommended mounting position is to bolt down on heatsink with silicone thermal compound for maximum heat transfer with #6 screw

RATINGS AND CHARACTERISTIC CURVES LS6GB60

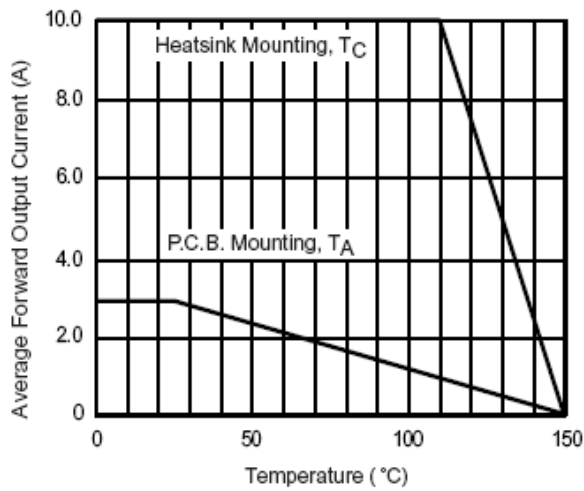

Figure 1. Derating Curve Output Rectified Current

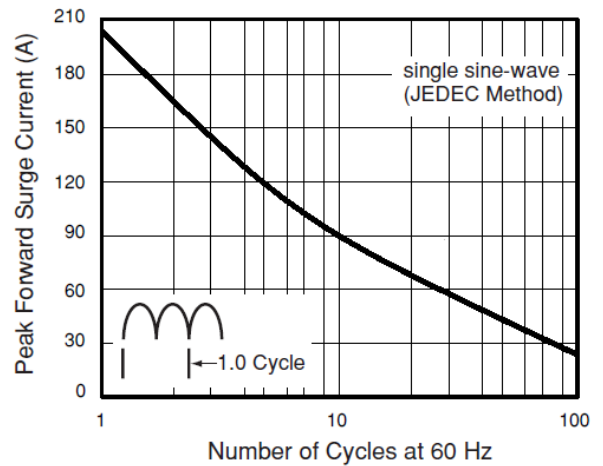

Fig. 2 - Maximum Non-Repetitive Peak Forward Surge Current Per Leg

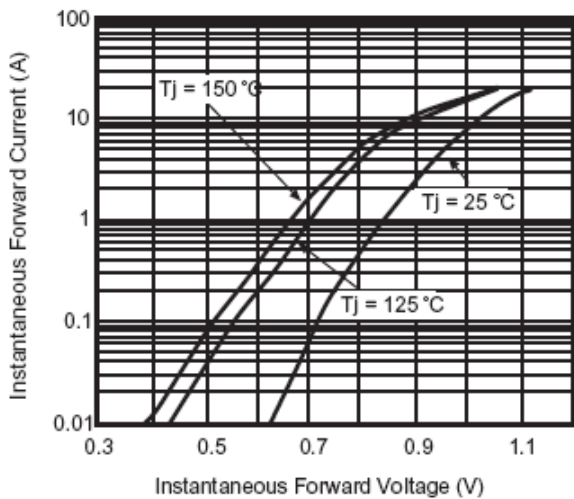

Figure 3. Typical Forward Characteristics Per Leg

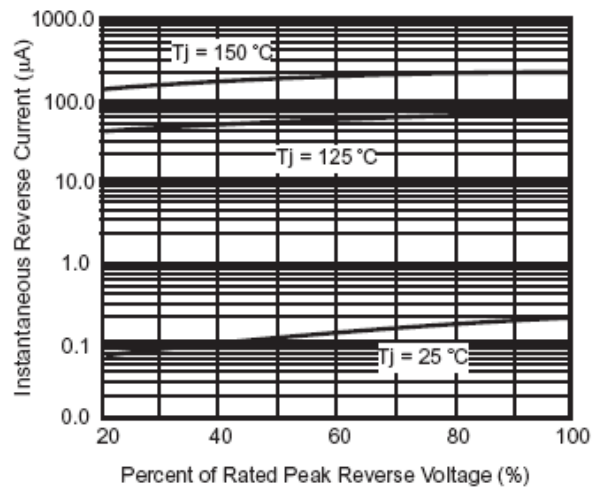

Figure 4. Typical Reverse Characteristics Per Leg

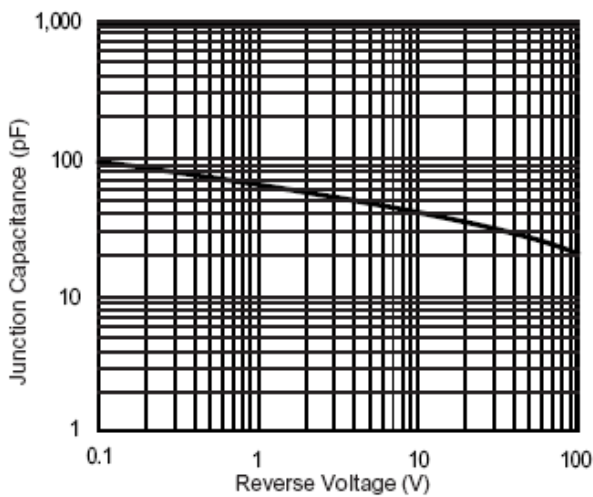

Figure 5. Typical Junction Capacitance Per Leg

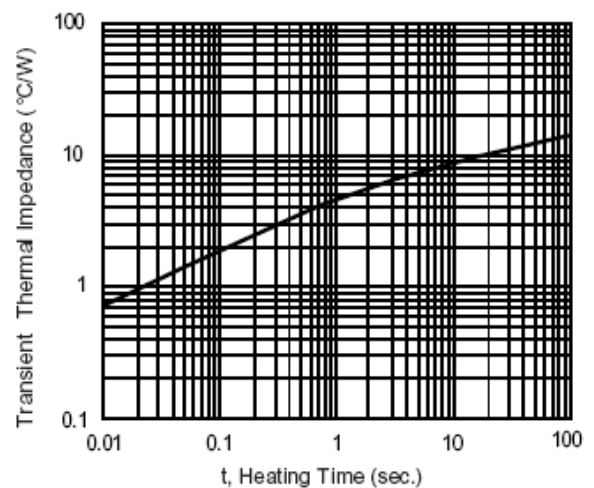

Figure 6. Typical Transient Thermal Impedance