

LV20GB60-E

SINGLE PHASE GLASS PASSIVATED LOW VF BRIDGE RECTIFIER

Voltage: 600V

Current: 20A

Features

Glass passivated chip junction
 Ideal for printed circuit board
 High surge current capability
 High case dielectric strength
 Low forward voltage
 This series is UL listed under Recognized Component Index, file number E330278
 Halogen Free

Mechanical Data

Terminal: Plated leads solderable per J-STD-002
 Case: UL-94 Class V-0 recognized Halogen Free Epoxy
 Polarity: Polarity symbol marked on body
 Mounting position: any

GSIB-5S

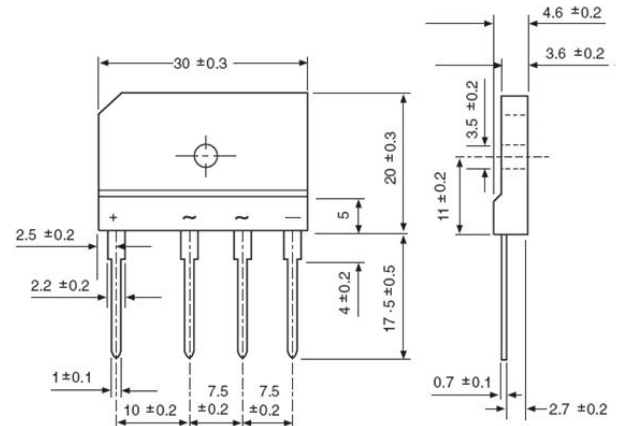

Dimensions in millimeters

MAXIMUM RATINGS AND ELECTRICAL CHARACTERISTICS

(single-phase, half -wave, 60Hz, resistive or inductive load rating at 25°C, unless otherwise stated)

	Symbol	LV20GB60-E	units
Maximum repetitive peak reverse voltage	V _{rrm}	600	V
Maximum RMS voltage	V _{rms}	420	V
Maximum DC blocking voltage	V _{dc}	600	V
Maximum average forward Rectified output current at T _c = 87°C (Note 1) Ta = 25°C (Note 2)	I _{f(av)}	20.0 3.5	A
Peak forward surge current single sine-wave superimposed on rated load (JEDEC Method)	I _{fsm}	240	A
Maximum instantaneous forward voltage drop per leg at 10A	V _f	0.90	V
Rating for fusing (t < 8.3ms)	I ² t	240	A ² Sec
Maximum DC reverse current at rated DC blocking voltage per leg Ta = 25°C Ta = 125°C	I _r	10.0 250	μA
Maximum thermal resistance per leg (Note2) (Note1)	R _{th(ja)} R _{th(jc)}	22.0 1.5	°C/W
Operating junction and storage temperature range	T _j , T _{stg}	-55 to +150	°C

Note:

1. Unit case mounted on Al plate heatsink
2. Unit case mounted on P.C.B. with heatsink
3. Recommended mounting position is to bolt down on heatsink with silicone thermal compound for maximum heat transfer with #6 screw

RATINGS AND CHARACTERISTIC CURVES LV20GB60-E

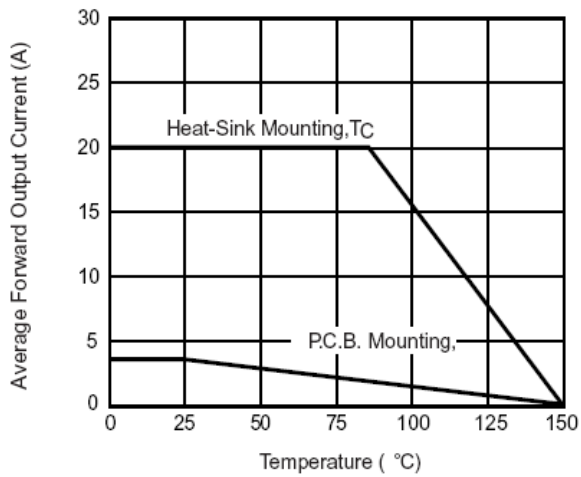

Figure 1. Derating Curve Output Rectified Current

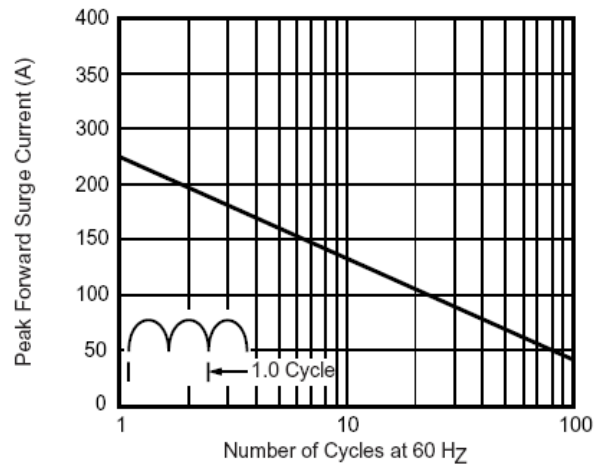

Figure 2. Maximum Non-Repetitive Peak Forward Surge Current Per Leg

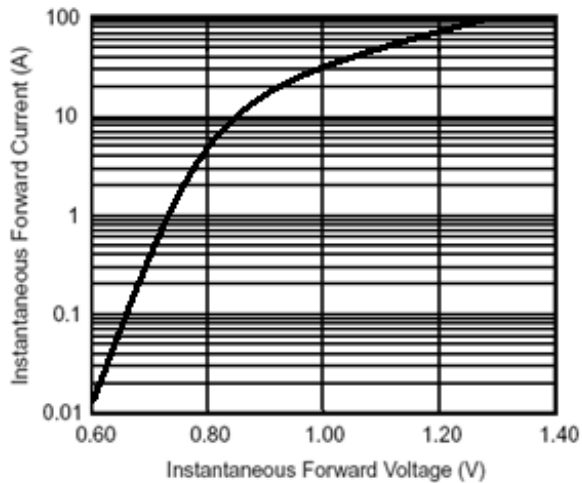

Figure 3. Typical Forward Characteristics Per Leg

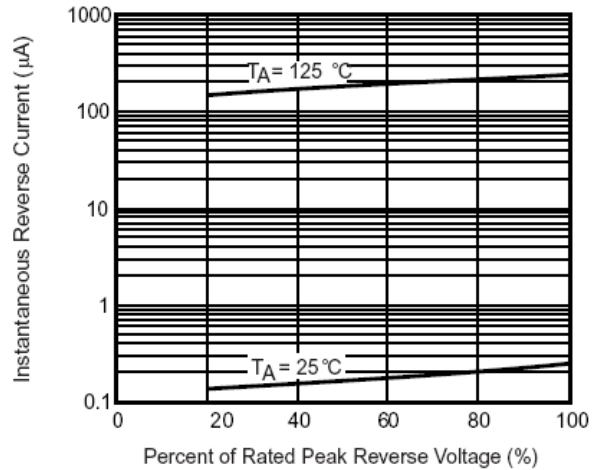

Figure 4. Typical Reverse Characteristics Per Leg

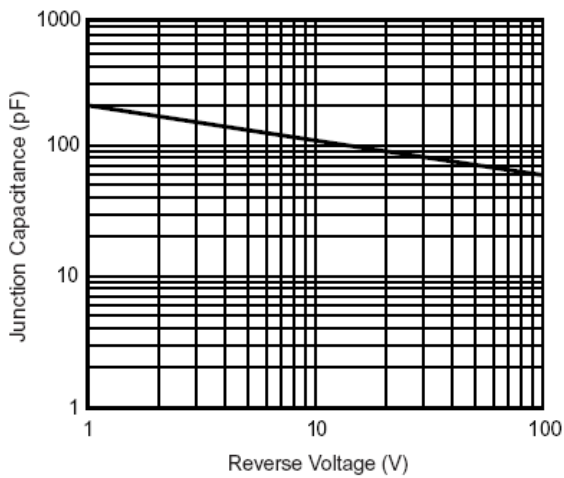

Figure 5. Typical Junction Capacitance Per Leg

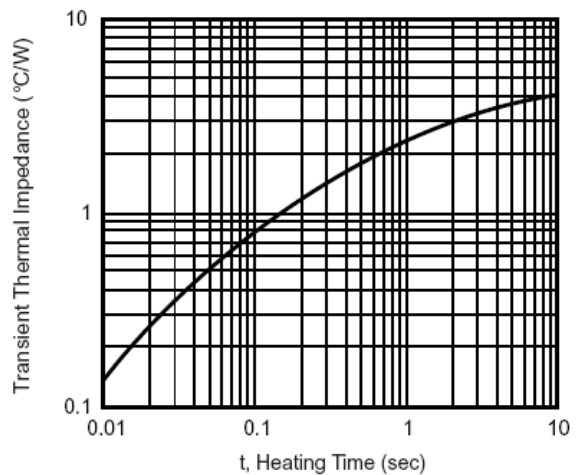

Figure 6. Typical Transient Thermal Impedance